

# Keysight E4729A

## SystemVue Consulting Services

### DOCSIS 3.1 Baseband Verification Library

SystemVue Algorithm Reference Library for Data-Over-Cable Service Interface Specifications (DOCSIS 3.1), Intended for System Architecture, Baseband Algorithms and RF Component Verification

## Technical Overview

### Introduction

DOCSIS 3.1 provides a way for cable operators to increase capacity and speed, with up to 50 percent more data through-put over the same spectrum than DOCSIS 3.0, and the ability to deliver 2.5 Gbps in the upstream and 10 Gbps in the down-stream on an existing Hybrid Fiber Coaxial (HFC) network. DOCSIS 3.1 achieves its capacity increase—as much as 50 percent in the upstream and downstream signal directions—through the use of orthogonal frequency-division multiplexing (OFDM) and low-density parity-check (LDPC) forward error correction (FEC) technology. The standard mandates the use of up to 4096 QAM modulation with a 24- to 192-MHz channel bandwidth in the downstream, and up to 4096 QAM modulation with up to a 96-MHz bandwidth in the upstream. It also supports pure Intellectual Property (IP) payload data, can co-exist with legacy channels on the existing HFC infrastructure and is backward-compatible with the large installed base of earlier DOCSIS gear.

The Keysight Technologies, Inc. DOCSIS 3.1 Baseband Verification Library is an optional add-on library for SystemVue, providing reference designs for DOCSIS 3.1 fully coded sources and receivers for both downstream and upstream signals (Figures 1 and 2). It enables end-to-end simulation modeling for DOCSIS 3.1 systems.

## Who should use the DOCSIS library?

System-level architects, baseband algorithm designers and RF component designers can use the DOCSIS 3.1 library to perform early system validation, with or without working baseband or RF hardware. SystemVue is also scriptable, linkable to other platforms and connects to high-performance test equipment, providing both flexibility and consistency across the full product lifecycle.

The DOCSIS 3.1 library is intended for use in early research and development, and in academic research systems to enable the exploration of algorithm and system robustness in deep margin and interference situations.

## What can you do with the SystemVue DOCSIS 3.1 library?

With the SystemVue DOCSIS 3.1 library, users can simulate DOCSIS 3.1 system performance (including baseband Transmitter (Tx)/Receiver (Rx) algorithms and RF impairments); with or without DOCSIS 3.0 SC-QAM system interference.

- **Baseband Modeling:** Replace algorithms in the DOCSIS 3.1 reference design with your own custom algorithms in C++, math .m, or HDL formats, or use graphically-defined schematics. SystemVue also conveniently integrates with MATLAB for IP compatibility and portability.
- **System Modeling:** Evaluate algorithms under user-defined fading, noise and interference (e.g., analog TV, DOCSIS 3.0 SC-QAM and LTE). RF impairments can also be included.
- **Research and Emerging Standards:** Investigate advanced channel coding techniques such as LDPC and OFDM in video systems. Provide a platform to investigate DOCSIS 3.1 system performance with, for example, different windowing functions, time interleaving depths and the number of continuous pilots.
- **RF Component Evaluation:** Fill gaps for RFIC/RF module designers who want to assess system-level performance based on simulated or tested analog designs. SystemVue can interact with the Keysight ADS and GoldenGate RF EDA simulators, with X-parameters\*, and more.

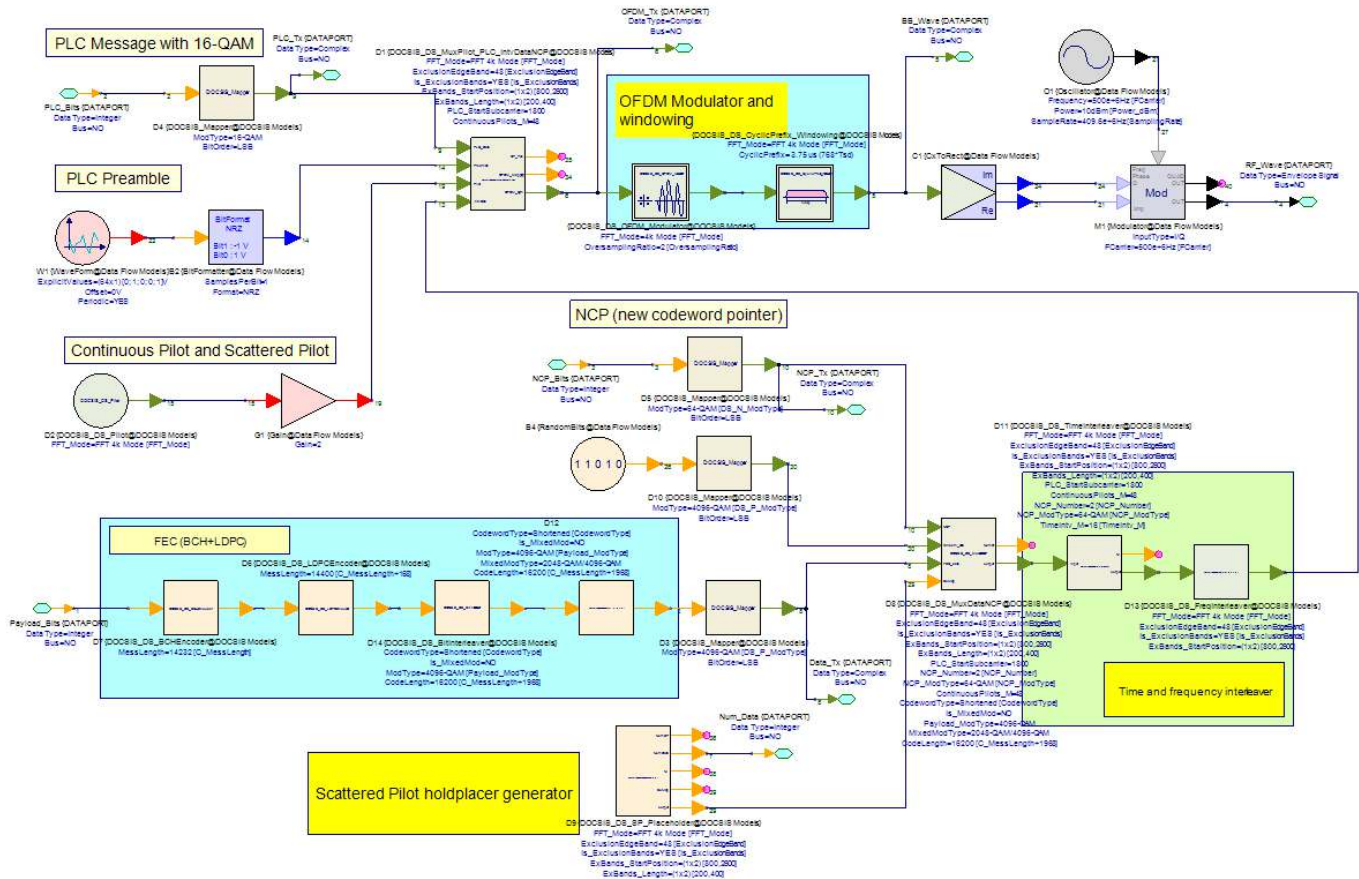

Figure 1. Underlying Simulation schematic of DOCSIS3.1 coded source (user-modifiable).

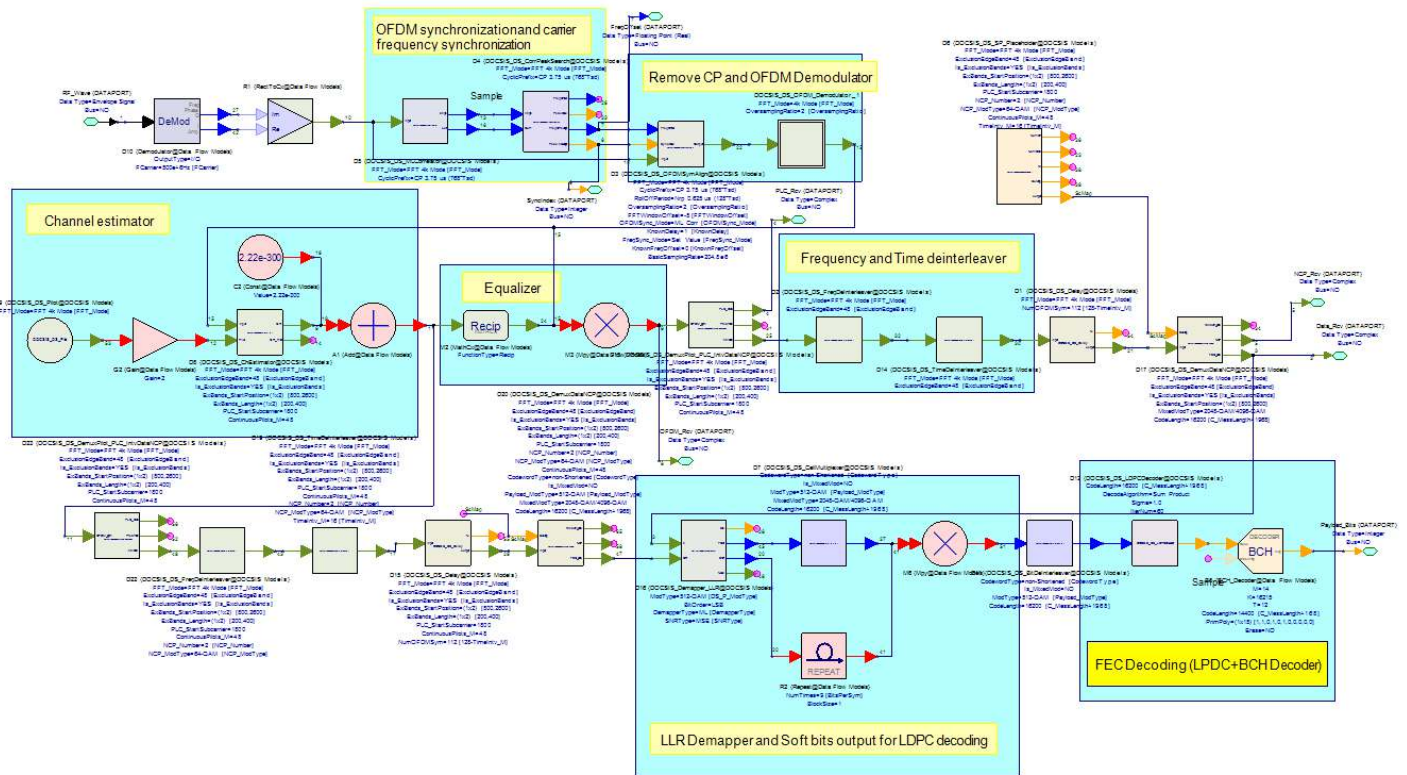

Figure 2. Underlying Simulation schematic of DOCSIS3.1 coded receiver (user-modifiable).

## Test Benches

In DOCSIS 3.1, FEC adopts LDPC+BCH—the outer code is BCH, while the inner code is LDPC. The DOCSIS 3.1 library provides an example that allows users to test the Bit-Error-Rate (BER) with LDPC coding/decoding. The example is illustrated in Figure 3. The BER vs Eb/No curves are shown for 16-QAM, 64-QAM, 128-QAM, 256-QAM, 512-QAM, 1024-QAM, 2048-QAM and 4096-QAM, respectively. The BER vs Eb/No curves with FEC and w/o FEC are also shown in the workspace.

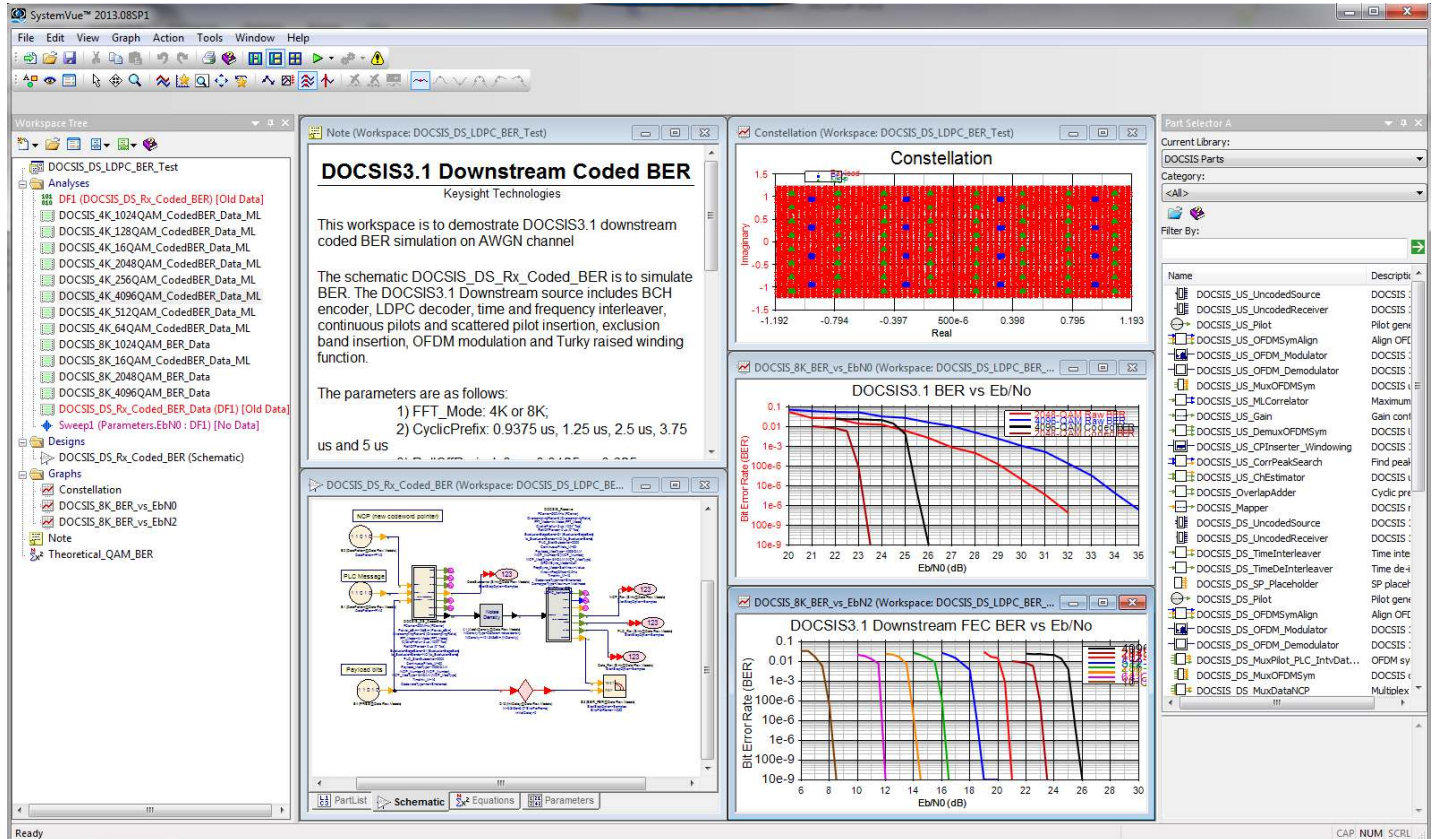

Figure 3. Workspace of DOCSIS3.1 Downstream BER test bench on Additive White Gaussian Noise (AWGN) channel.

Figure 4 is an example to simulate raw BER (without FEC) of DOCSIS 3.1 upstream. The BER vs Eb/No curves, RMSE vs Eb/No curves, and demodulated constellation are shown in the workspace.



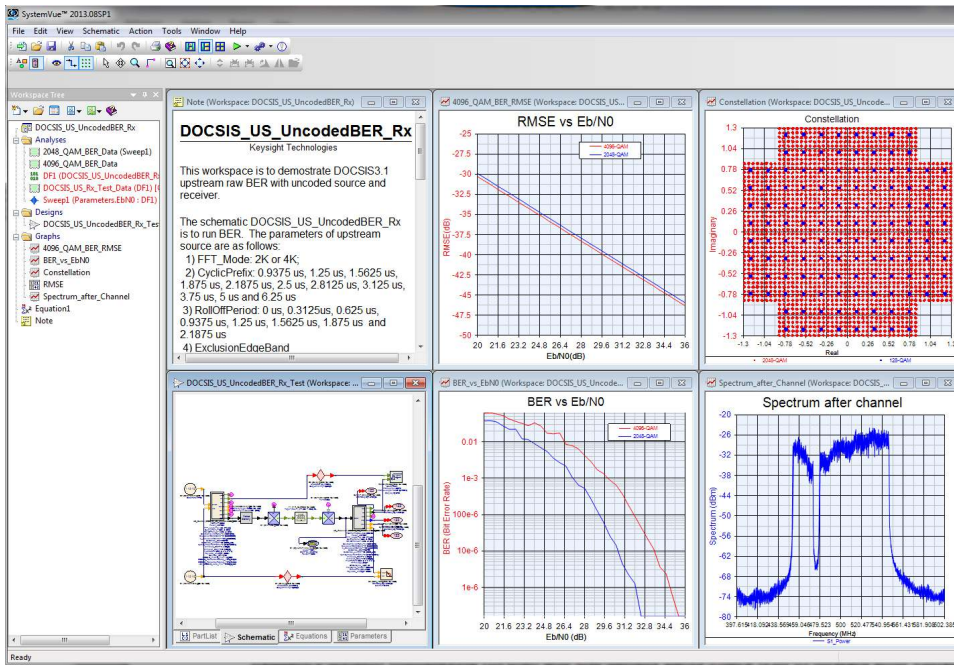

Figure 4. Workspace of DOCSIS3.1 Upstream BER test bench on static channel.

Figure 5 shows an example that can be used to measure the DOCSIS3.1 Downstream Modulation-Error-Ratio (MER) with DOCSIS3.0 SC-QAM interference. The VSA 89600 analysis result with filtering is shown in Figure 6.

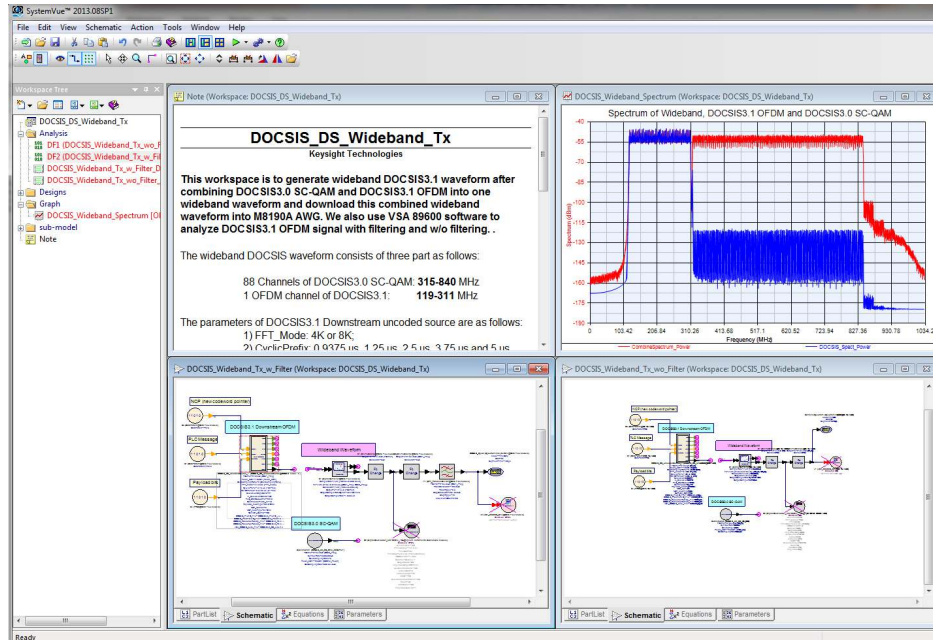

Figure 5. Workspace of DOCSIS 3.1 Downstream and DOCSIS 3.0 SC-QAM Wideband waveform generation . Uses VSA software to analyze DOCSIS 3.1 Downstream signal.

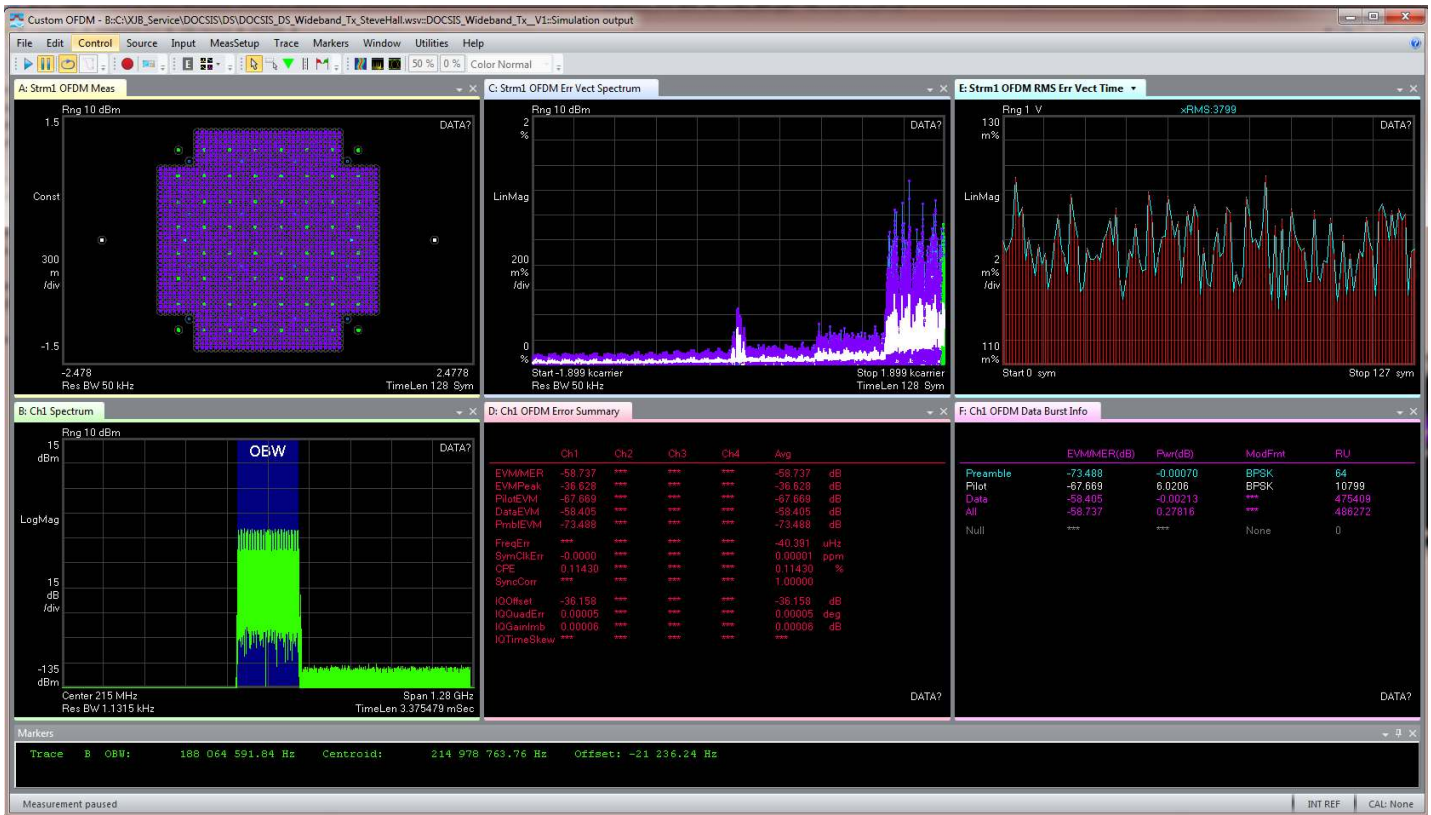

Figure 6. VSA analysis results for this filtering DOCSIS 3.1 downstream waveforms.

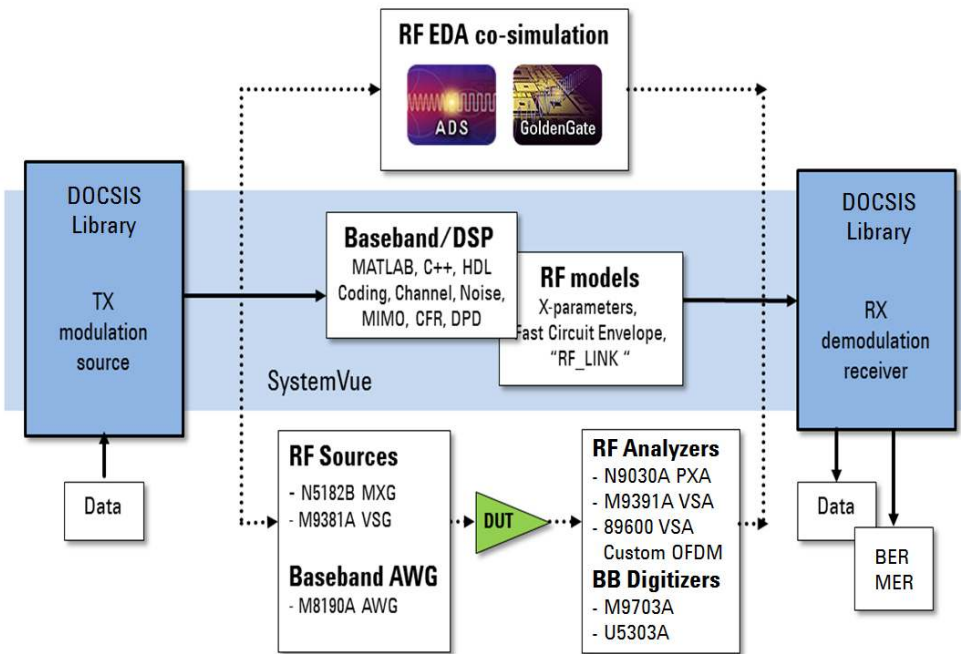

Figure 7. The DOCSIS3.1 Library can also be used with other Keysight design software and test instruments.

Figure 8 is a workspace to work with M8190A and M9703A to measure BER.

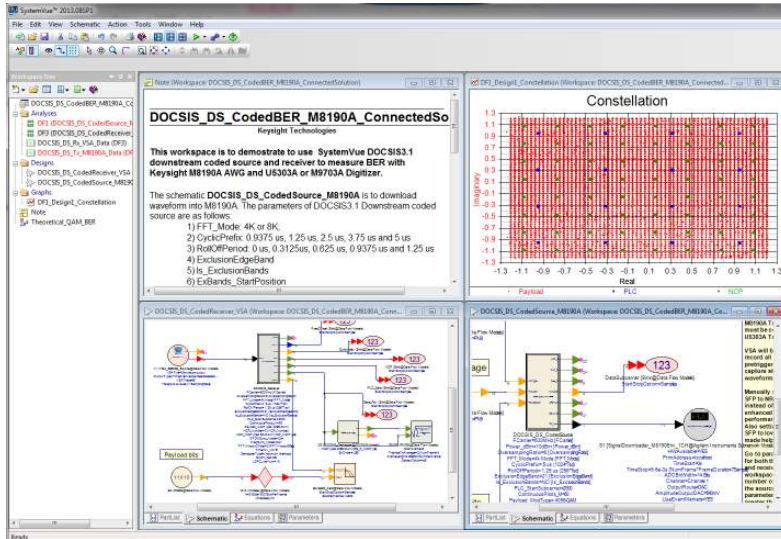

Figure 8. Workspace of DOCSIS3.1 Downstream source and receiver with M8190A and M9703A to measure BER.

## Configuration

The DOCSIS 3.1 Baseband Verification Library can be added as an option to any W146x-series SystemVue environment or bundle (Figure 9). The DOCSIS 3.1 library can also be used with SystemVue's W1902 Digital Modem Library to generate wideband waveforms, such as an OFDM channel with 192-MHz bandwidth (DOCSIS 3.1 downstream) and 88 SC-QAM channels.

Complementary Keysight software (such as Keysight I/O libraries, Command Expert, and the 89600 VSA with option 300) is often used to connect SystemVue to families of Keysight test equipment, including Arbitrary Waveform Generators (AWGs), digitizers, RF sources, RF analyzers, and more. SystemVue offers a convenient modeling and verification platform that can be used in the research and development environment, test lab or shared over a network.

## Ordering Information

### Required software configuration

- W1461BP SystemVue Comms Architect
- E4729A Consulting Services (requires quotation)
- Delivers software simulation library for choice of:
  - DOCSIS 3.1 Downstream TX & RX
  - DOCSIS 3.1 Upstream TX & RX

### T&M instruments commonly used with this configuration

- M8190A wideband baseband AWG
- 89600 Vector Signal Analysis software (option BHF for OFDM demodulation is recommended)

See also *DOCSIS 3.1 Application Brief 5991-4301EN*

## More Information

For more detailed application information, refer to:  
[www.keysight.com/find/eesof-systemvue-info](http://www.keysight.com/find/eesof-systemvue-info)  
[www.keysight.com/find/eesof-systemvue-videos](http://www.keysight.com/find/eesof-systemvue-videos)  
[www.keysight.com/find/eesof-systemvue-evaluation](http://www.keysight.com/find/eesof-systemvue-evaluation)

**myKeysight** **myKeysight**  
[www.keysight.com/find/mykeysight](http://www.keysight.com/find/mykeysight)  
 A personalized view into the information most relevant to you.

[www.keysight.com/find/](http://www.keysight.com/find/)

For more information on Keysight Technologies' products, applications or services, please contact your local Keysight office. The complete list is available at: [www.keysight.com/find/contactus](http://www.keysight.com/find/contactus)

### Americas

Canada	(877) 894 4414
Brazil	55 11 3351 7010
Mexico	001 800 254 2440
United States	(800) 829 4444

### Asia Pacific

Australia	1 800 629 485
China	800 810 0189
Hong Kong	800 938 693
India	1 800 112 929
Japan	0120 (421) 345
Korea	080 769 0800
Malaysia	1 800 888 848
Singapore	1 800 375 8100
Taiwan	0800 047 866
Other AP Countries	(65) 6375 8100

### Europe & Middle East

Austria	0800 001122
Belgium	0800 58580
Finland	0800 523252
France	0805 980333
Germany	0800 6270999
Ireland	1800 832700
Israel	1 809 343051
Italy	800 599100
Luxembourg	+32 800 58580
Netherlands	0800 0233200
Russia	8800 5009286
Spain	800 000154
Sweden	0200 882255
Switzerland	0800 805353
	Opt. 1 (DE)
	Opt. 2 (FR)
	Opt. 3 (IT)
United Kingdom	0800 0260637

For other unlisted countries:  
[www.keysight.com/find/contactus](http://www.keysight.com/find/contactus)  
 (BP-09-23-14)

\*X-parameters is a trademark and registered trademark of Keysight Technologies in the United States, European Union, Japan and elsewhere. The X-parameters format and underlying equations are open and documented. For more information, visit [www.keysight.com/find/eesof-x-parameters-info](http://www.keysight.com/find/eesof-x-parameters-info).

